

Panasonic

LD Auto Reverse
Multi Laser Disc Player

LX-900 ^U _{CA}
Operating Instructions



Front

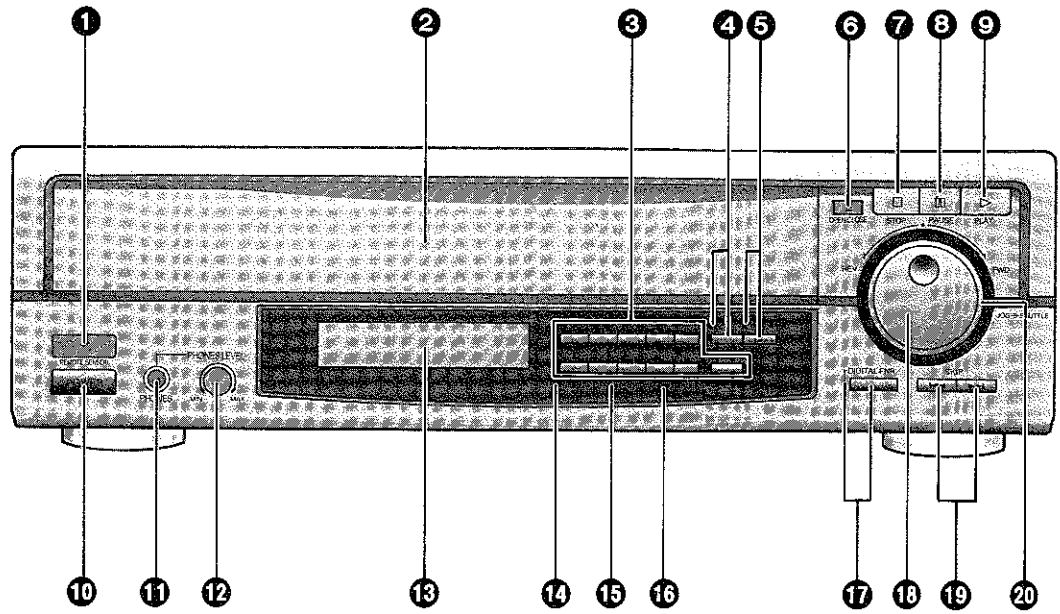

Remote Control

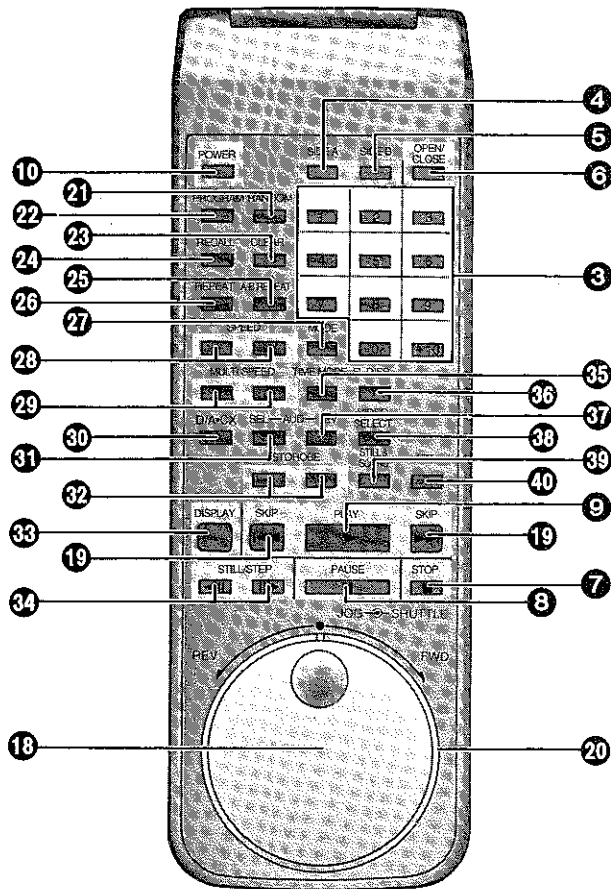

Information for Your Safety

Note:

This unit can be used only where the power supply is AC 120 V 50-60 Hz. It cannot be used elsewhere.

The model number and serial number of this product can be found on either the back or the bottom of the unit. Please note them in the space provided below and retain this booklet as a permanent record of your purchase to aid identification in the event of theft.

MODEL NUMBER _____

SERIAL NUMBER _____

CAUTION:

THIS PRODUCT UTILIZES A LASER. USE OF CONTROLS OR ADJUSTMENTS OR PERFORMANCE OF PROCEDURES OTHER THAN THOSE SPECIFIED HEREIN MAY RESULT IN HAZARDOUS RADIATION EXPOSURE. DO NOT OPEN COVERS AND DO NOT REPAIR YOURSELF. REFER SERVICING TO QUALIFIED PERSONNEL.



CAUTION

**RISK OF ELECTRIC SHOCK
DO NOT OPEN**



CAUTION: TO REDUCE THE RISK OF ELECTRIC SHOCK, DO NOT REMOVE COVER (OR BACK). NO USER-SERVICEABLE PARTS INSIDE. REFER SERVICING TO QUALIFIED SERVICE PERSONNEL.



This symbol warns the user that uninsulated voltage within the unit may have sufficient magnitude to cause electric shock. Therefore, it is dangerous to make any kind of contact with any inside part of this unit.



This symbol alerts the user that important literature concerning the operation and maintenance of this unit has been included. Therefore, it should be read carefully in order to avoid any problems.

CAUTION: MULTI LASER DISC PLAYERS USE INVISIBLE LASER BEAM WHICH COULD CAUSE HAZARDOUS RADIATION EXPOSURE IF DIRECTED. BE SURE TO OPERATE THE PLAYER CORRECTLY AS INSTRUCTED.

WARNING:

TO REDUCE THE RISK OF FIRE OR SHOCK HAZARD, DO NOT EXPOSE THIS EQUIPMENT TO RAIN OR MOISTURE.

TO REDUCE THE RISK OF FIRE OR SHOCK HAZARD AND ANNOYING INTERFERENCE, USE THE RECOMMENDED ACCESSORIES ONLY.

FCC NOTE: (U.S. Only)

This device complies with Part 15 of the FCC Rules. To assure continued compliance, follow the attached installation and do not make any unauthorized modifications.

This equipment has been tested and found to comply with the limits for a Class B digital device, pursuant to Part 15 of the FCC Rules. These limits are designed to provide reasonable protection against harmful interference in a residential installation. This equipment generates, uses, and can radiate radio frequency energy and, if not installed and used in accordance with the instructions, may cause harmful interference to radio communications. However, there is no guarantee that interference will not occur in a particular installation. If this equipment does cause harmful interference to radio or television reception, which can be determined by turning the equipment off and on, the user is encouraged to try to correct the interference by one or more of the following measures:

- Reorient or relocate the receiving antenna.
- Increase the separation between the equipment and receiver.
- Connect the equipment into an outlet on a circuit different from that to which the receiver is connected.
- Consult the dealer or an experienced radio/TV technician for help.

CAUTION: (Canada Only)

- TO PREVENT ELECTRIC SHOCK DO NOT USE THIS (POLARIZED) PLUG WITH AN EXTENSION CORD, RECEPTACLE OR OTHER OUTLET UNLESS THE BLADES CAN BE FULLY INSERTED TO PREVENT BLADE EXPOSURE.
- This digital apparatus does not exceed the Class B limits for radio noise emissions from digital apparatus set out in the Radio Interference Regulations of the Canadian Department of Communications.

Inventory

Before you set up the unit, make sure that you have the following accessories:

- Infrared Remote Controller (With two ANSI "AA" size batteries)

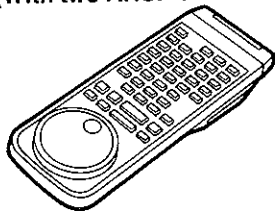

- AC Power Cord

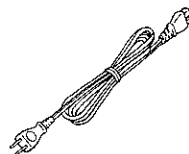

- Video Cord



- Audio Cord



Contents

Overview

Controls And Indications	6
Infrared Remote Controller	7
Connection	8
The Disc	10

Operations

Playback	12
Search Function	14
Various Playback	16
Programmed Playback	21
Repeat Playback	23

Helpful Hints

Audio Channel Selection	26
Multi-Function Display	27
On Screen Display	28
Cautions	30
Before Requesting Service	32
Specifications	33
Quick Reference	Back Cover

Controls And Indications

Front Panel

No.	Name	Page
1	Remote Sensor	7
2	Disc Tray	10
3	Numeric Buttons*	14
4	SIDE A Button with Lamp*	13
5	SIDE B Button with Lamp*	13
6	OPEN/CLOSE (Play) Button*	12
7	STOP Button*	12
8	PAUSE Button*	12
9	PLAY Button*	12
10	POWER Button*	12
11	PHONES Connector	13
12	PHONES LEVEL Control	13
13	Multi-Function Display	27
14	DISPLAY OFF Lamp	27
15	PROGRAM Lamp	27
16	RANDOM Lamp	27
17	DIGITAL FNR (Field Noise Reduction) Button with Lamp	20
18	JOG Dial*	17
19	SKIP Buttons*	14
20	SHUTTLE Ring*	16

*These buttons are on both the Player and the Remote Controller

Remote Controller

The following are special function buttons on only the Remote Controller.

No.	Name	Page
21	RANDOM Button	17
22	PROGRAM Button	21
23	CLEAR Button	15
24	RECALL Button	22
25	A-B REPEAT Button	23
26	REPEAT Button	23
27	MODE Button	15
28	SPEED Buttons	18
29	MULTI SPEED Buttons	18
30	D/A • CX Button	26
31	AUDIO SELECT Button	26
32	STROBE Buttons	20
33	DISPLAY (On Screen Indication) Button	28
34	STILL/STEP (Advance and Reverse) Buttons	18
35	TIME MODE Button	29
36	FL DISPLAY Button	20
37	AUDIO LEVEL Button	29
38	VIDEO SELECT Button	20
39	STILL & SOUND Button	19
40	ART Button	19

Infrared Remote Controller

Battery Loading

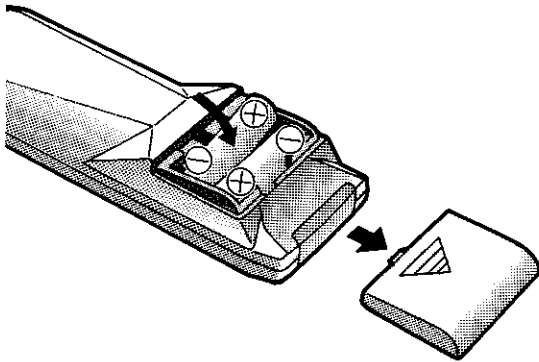

Remove the Battery Case Cover by pushing it in the direction of the arrow as shown above and load the batteries with their polarities (+ and -) aligned correctly.

■ Notes for Battery Use

- Do not use rechargeable batteries (i.e. nickel cadmium—NiCad batteries).
- Do not mix new and old batteries, or different brands of batteries
- Do not try to recharge or short-circuit the batteries
- Do not break batteries open, heat them or incinerate them
- Remove batteries when this unit is not in use for long periods of time
- Should the battery electrolytes leak, clean and wipe the Battery Case and load new batteries

■ Battery Life (When to exchange batteries)

Exchange the batteries with new ones about every 6 months. However, battery life depends on the frequency of use or the selected operation mode

- Use ANSI "AA" size batteries.

Remote Controller Operation

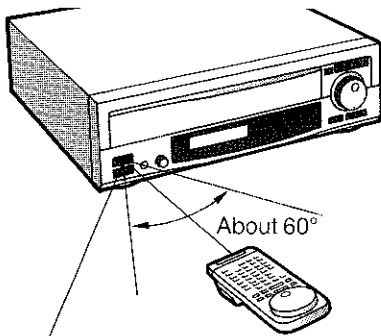

Remote Sensor
(Remote Control Receiver)

- Point the Remote Controller at the Remote Sensor (Remote Control Receiver) within about 7 m and within about 30° from the front of the Player (The operating distance varies with the room brightness)

■ Notes for Operation

- Do not expose the Remote Sensor to strong light
- Do not place any obstacles between the Remote Controller and the Remote Sensor.
- Do not use the Remote Controller simultaneously with another electric appliance's infrared remote controller

Connection

Carefully read the user's manual of appliances to be connected to this unit.

Connection with a Stereo System or a TV with Video/Audio Input

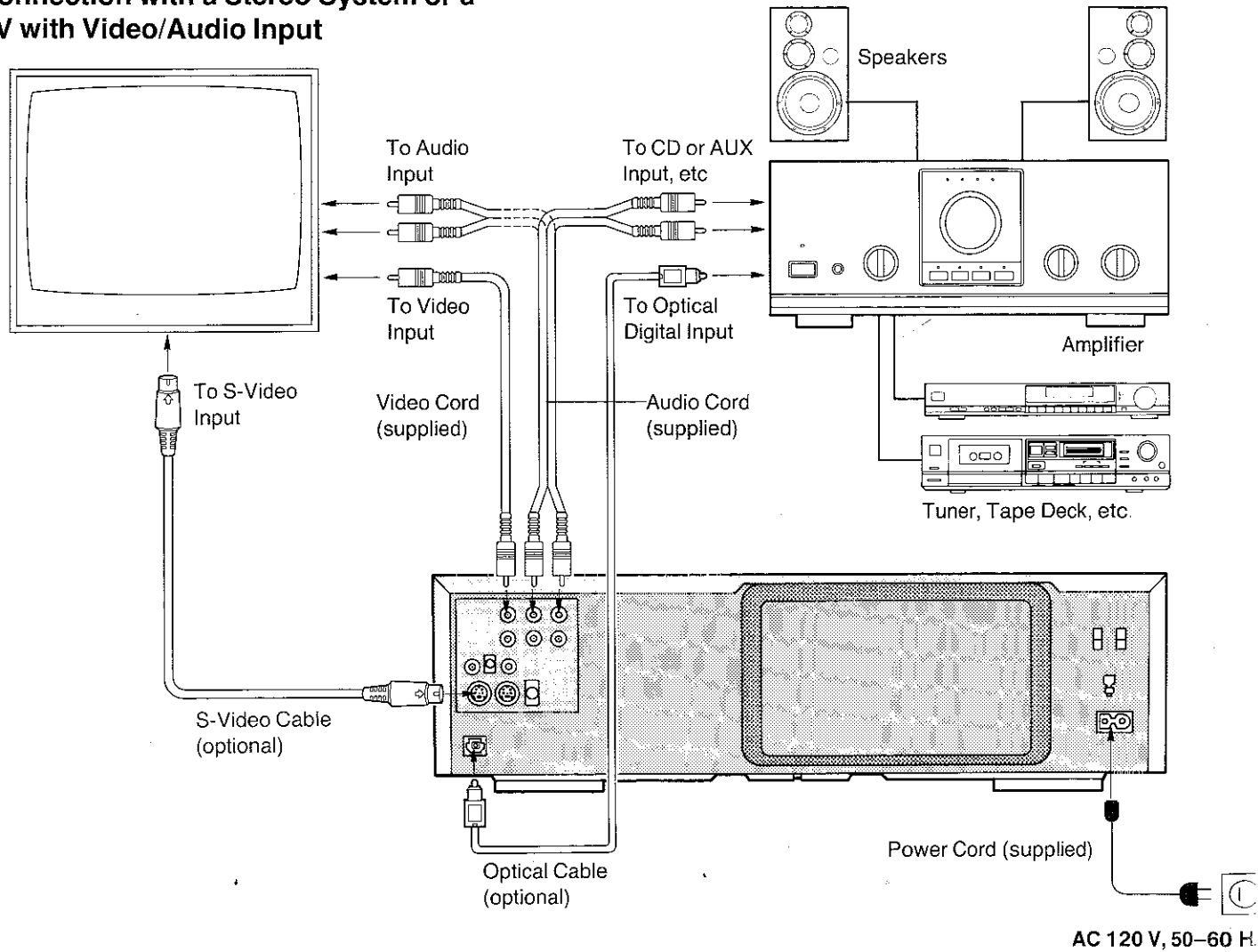

● Be especially careful not to raise the amplifier's volume so as to prevent the appliance's speakers being damaged

Notes:

- Use the S-Video Cable (optional) when connecting the unit to a TV with an S-Video Input Connector
- Use the Optical Cable (optional) when connecting the unit to a stereophonic amplifier with an Optical Digital Connector

How to connect with Optical Cable

(1) Remove the dust cap from the connector

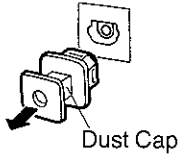

(2) Connect the cable.

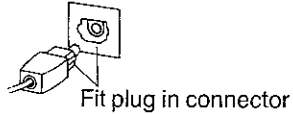

- This connector can be used only for the digital audio output, not for the analog audio output.
- The digital audio channel cannot be selected with AUDIO SELECT **31** Button

Optical Cable (optional)

- Use an optical cable with the length of less than 3 m
- Do not bend the optical cable.

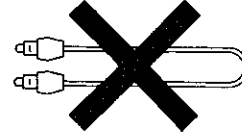

- If you roll the optical cable for storage, make sure that the internal diameter of the loops is greater than 15 cm

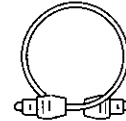

- Be especially careful not to scratch the plugs of the optical cable or leave it dusty
- If the plugs become dusty, wipe them with a soft cloth before connecting.

To Make Connection with a TV not having Video/Audio Input Connectors

Use an optional RF Adaptor PV-RF15.
(See the RF Adaptor operating instructions.)
The playback audio is mono.

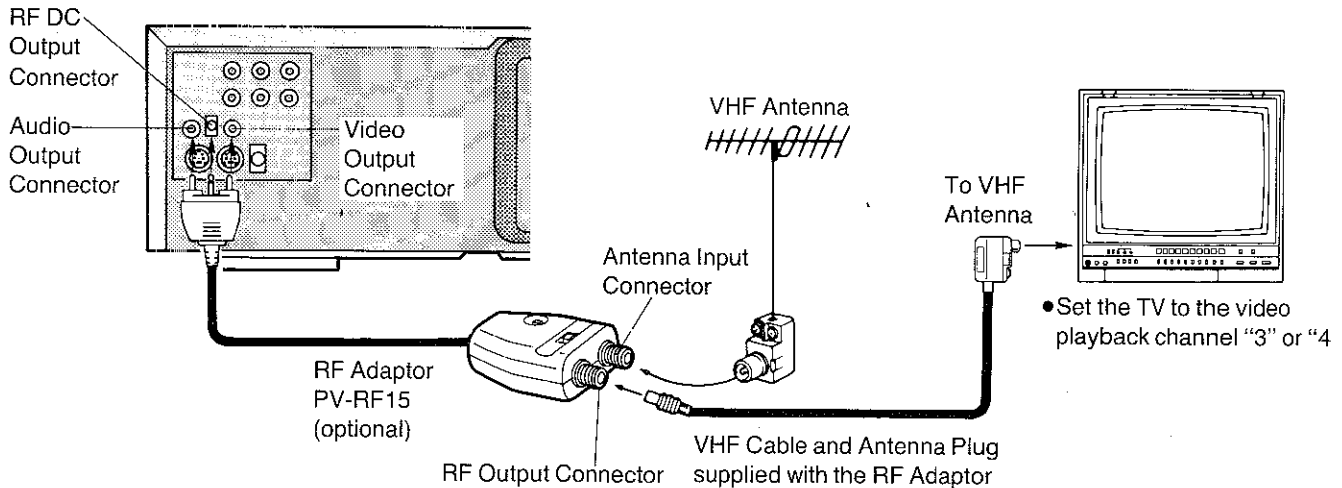

The Disc

Discs that can be played back

The unit can play back the following 6 kinds of laser discs without having to use any adaptor

CD (Compact Disc) Single

[Single side only]



CD

[Single side only]

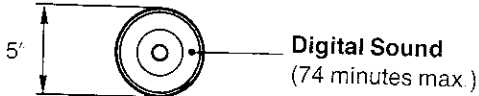

CDV (Compact Disc-Video)

[Single side only]

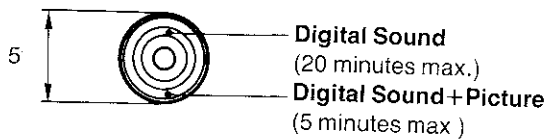

LD (Laser Disc) Single

[Single side only]

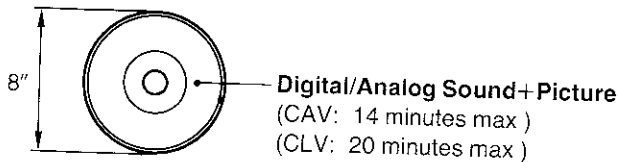

LD

[Both sides]

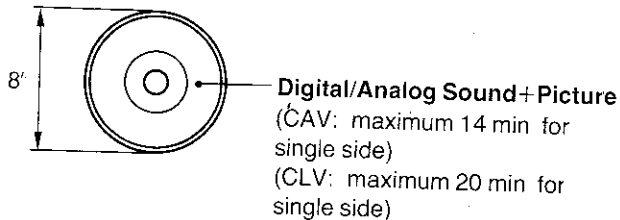

LD

[Both sides or single side only]

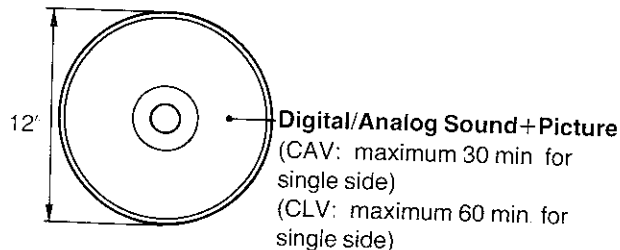

Handling the Disc

How to hold the Disc

- Hold the disc so that the disc's surface is not touched
- LD (12")/LD, LD Single (8") Discs

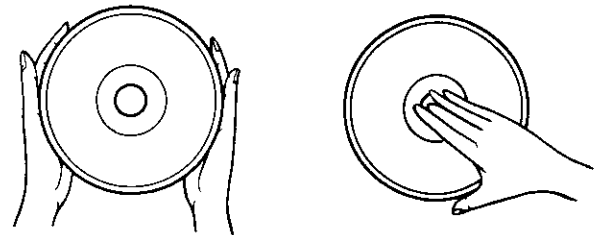

- CDV, CD (5")/CD Single (3") Discs

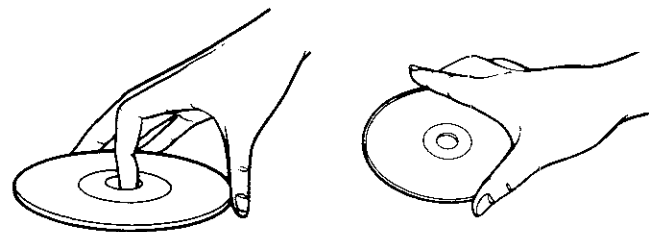

How to place the Disc on the Disc Tray

Place the disc in the proper recession according to its size

- LD Place the LD disc with the label of the side to be played facing upward
- LD single, CDV, CD Place the disc with the label facing upward

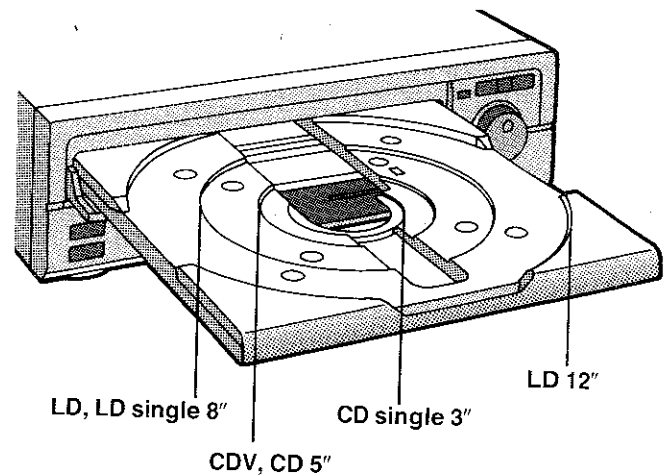

Operations

Playback

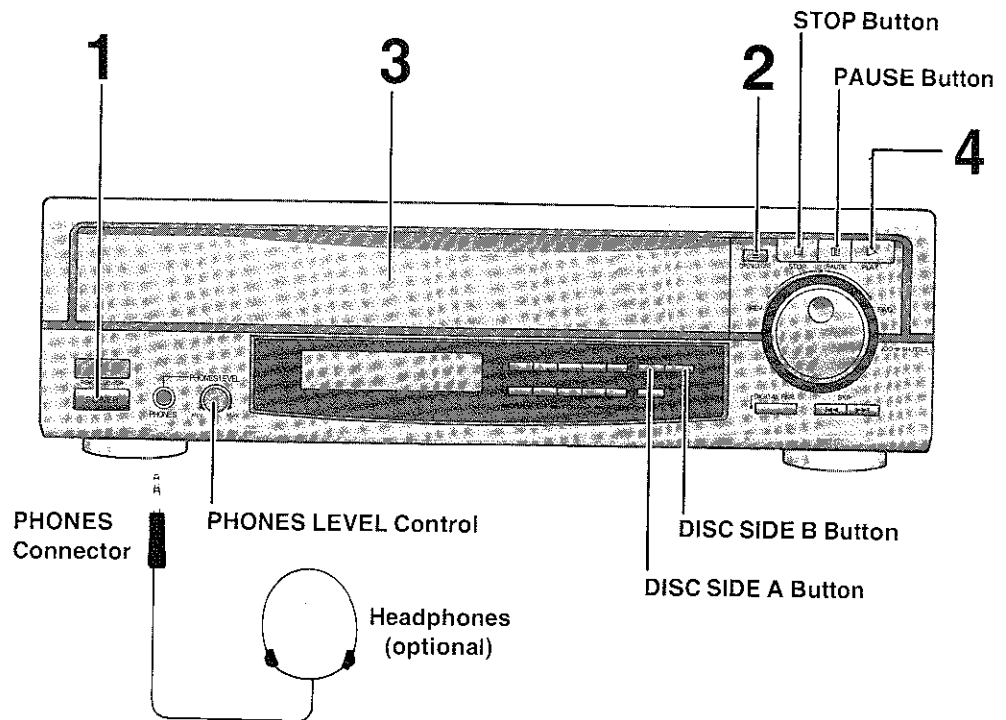

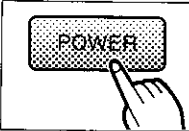
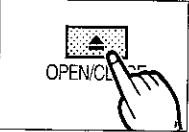
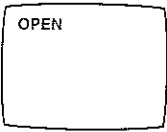
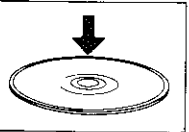
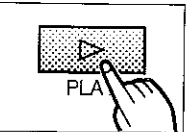
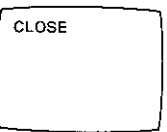
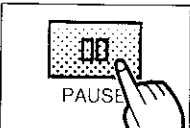
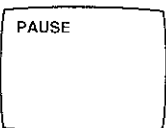
Operation	Display	Procedure
1 		Press POWER 10 Button.
2 		Press OPEN/CLOSE 6 Button.
3 		Insert the disc.
4 		Press PLAY 9 Button.
■ To stop Playback Press STOP 7 Button		
■ To interrupt the Playback Temporarily		
		Press PAUSE 8 Button. • Press PAUSE Button again to playback

To change Side of the Disc [LD]

The title label side is called Side A and the opposite side is Side B. The explanations in this manual are based on a disc being placed in the Disc Tray with the title label side (Side A) upwards.

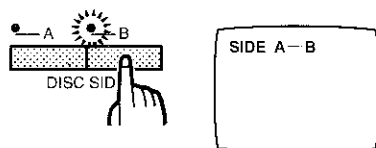

During Playback,
To play back Side B
Press **DISC SIDE B 5 Button**.

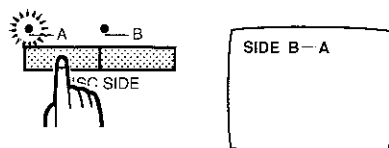

To select Side A during Side B playback
Press **SIDE A 4 Button**.

Last Memory Function [LD]

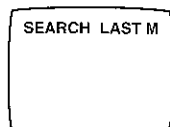

When you press **STOP 7 Button** during the playback of an LD, the unit memorizes the point where the playback was stopped. If you press **PLAY 9 Button** in the stop mode, playback starts a little before the stop point of the previous playback. If any operation other than playback is performed in the stop mode, the Last Memory Function is cancelled. Removing the LD from the unit also cancels this function.

- This function does not work during Program Playback and Repeat Playback.

PHONES 11 Connector

You can listen to bilingual or stereophonic sound by connecting your headphone to this connector.

- The volume level can be adjusted with **PHONES LEVEL 12 Control**.
- Avoid listening with your headphones for an extended time at a loud volume as it may affect your hearing.

Notes:

- During playback, do not tilt or lift the unit, or subject it to strong impact.
- Do not open the Disc Tray with your hand.
- Strong pressure or impact should not be given to the opened Disc Tray, this will damage the unit. Therefore, be especially careful not to leave the unit with the Disc Tray open.

Search Function

Chapter/Track Skip Function (How to perform skip playback)

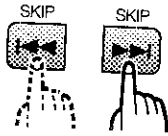

During playback,
Press **Skip (Forward or Backward)**  Button.

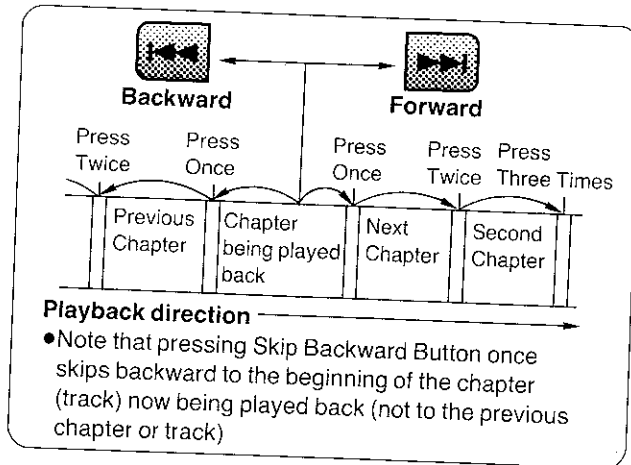

Chapter/Track Search Function (How to playback a disc from the desired chapter or track)

Example: To playback at the beginning of chapter (track) number 3;

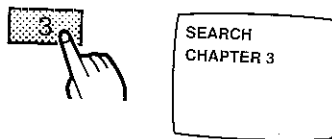

Press Numeric Button "3"

- Chapter (track) 3 will be played back
- If the display "CHAPTER" does not appear on the TV screen when an LD disc is loaded, press Mode Button on the Remote Controller to display "CHAPTER".
- If a wrong chapter (track) number is selected, press the correct Numeric Button again

- To playback a Chapter or Track Number of 10 or above

Use the "+10" Button.

Example: To access chapter 14;
Press "+10" → "4"
To access chapter 20;
Press "+10" → "+10" → "0"

- To playback the Beginning of the Desired Chapter on B Side

Press **Side B** Button and then **Numeric** Button

Notes for Chapter Skip and Search Functions (LD)

- These functions do not work with discs on which no chapters have been recorded
- If the chapter number beyond the number of chapters recorded on an LD disc without a TOC signal is designated for Skip or Search playback, the segment a little before the end of the disc is played back
- If no chapter number is designated by the Numeric Button after displaying the indication "CHAPTER" on the TV screen, the indication remains displayed until the Clear Button is pressed

Note for Track Search Function (CD, CDV or LD with a TOC signal)

If a chapter (track) number unrecorded on a disc is designated the message "ERROR" flashes on and off on the TV screen, and the indication "E" on the unit's Multi-Function Display. The Track Search function does not work

Frame Search Function LD [LD (CAV)]

Example: To start playback from frame number 15000

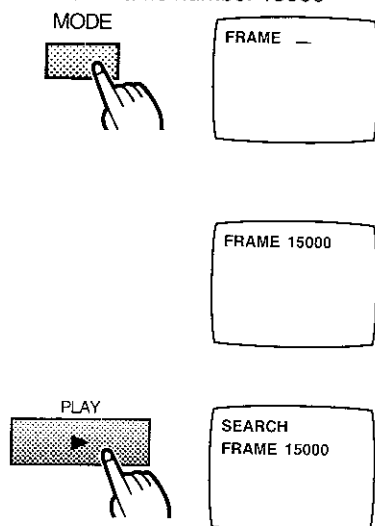

- 1 Press Mode 27 Button** during playback.
 - Press this button until the display "FRAME" appears on the TV screen.
 - This step is not necessary for a disc on which no chapters have been recorded
- 2 Press Numeric 3 Buttons** "1" → "5" → "0" → "0" → "0".
 - If you press a wrong Numeric Button, press **Clear 23 Button** and then the correct Numeric Button.
- 3 Press Play 9 Button.**
 - Playback starts from the designated frame
 - If you perform Frame Search during Still playback, the designated frame will also be played back in the still picture

Time Search Function [LD (CLV)]

Example: To start playback at the position "15 minutes 00 seconds" from the beginning of the disc

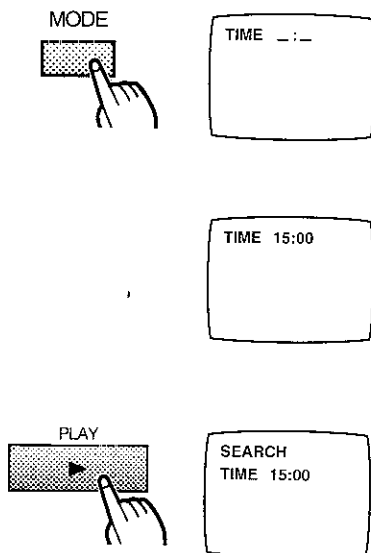

- 1 Press Mode 27 Button** during playback.
 - Press the button until the display "TIME" appears on the TV screen.
 - This step is not necessary for a disc on which no chapters have been recorded.
- 2 Press Numeric 3 Buttons** "1" → "5" → "0" → "0".
 - If you press a wrong Numeric Button, press **Clear 23 Button** and then the correct Numeric Button
- 3 Press Play 9 Button.**
 - Playback starts from the designated time number

Notes:

- If a double-faced LD is used, you can designate the desired frame number on the reverse side by pressing **DISC SIDE A** or **B Button** to start playback of the reverse side and designate the frame number.
- If an unrecorded frame number is designated, the segment a little before the end of the disc is played back

- If a disc has time numbers recorded only in minutes, playback starts from the beginning of the designated minute even if the seconds are designated.
- If a double-faced LD is used, you can designate the desired time number on the reverse side by pressing **DISC SIDE A** or **B Button** to start playback of the reverse side and designate the time number
- If an unrecorded time number is designated, the segment a little before the end of the disc is played back.

Various Playback

Playback Using the Shuttle Ring

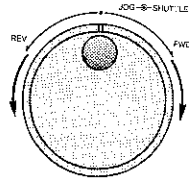

Rotate **SHUTTLE** Ring 20

[LD] [CDV (Video Part)]

■ From Playback

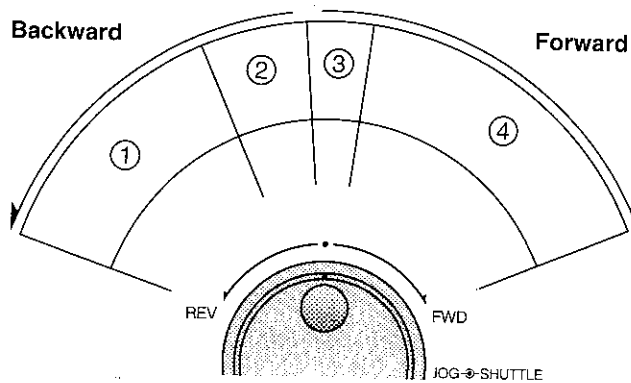

- ① Review Playback
- ② Reverse Playback
- ③ Normal Playback
- ④ Cue Playback

■ From Pause/Still Playback

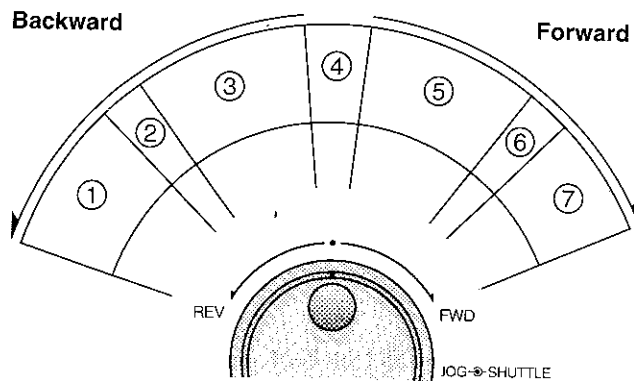

- ① Review Playback
- ② Reverse Playback
- ③ Reverse Slow Playback
- ④ Still Playback
- ⑤ Slow Playback
- ⑥ Normal Playback
- ⑦ Cue Playback

Note:

No audio is reproduced during the various playback even if SHUTTLE Ring is set to the Normal Playback position

[CD] [CDV (Audio Part)]

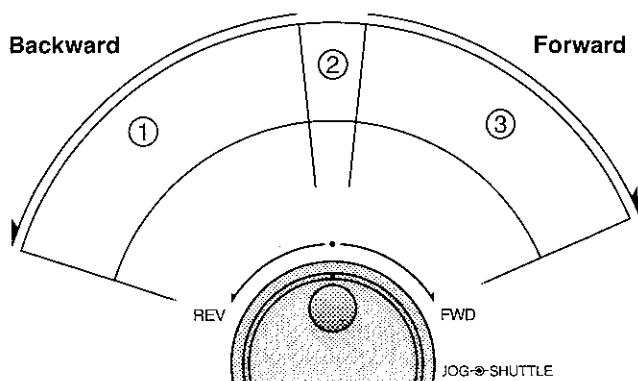

- ① Review Playback
- ② Playback or Pause
- ③ Cue Playback

- If Shuttle Ring is rotated during playback, its center position resumes the playback. If it is rotated in the pause mode, its center position returns the unit to the pause mode.

Playback Using the Jog Dial

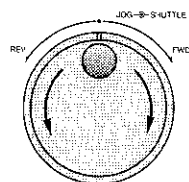

Rotate JOG Dial 18

- Rotating JOG Dial one click during playback starts the still picture playback (if an audio part of CDV or a CD is played back, the unit changes to the pause mode).
- Rotating Jog Dial clockwise and counterclockwise advances and reverses the picture respectively

■ To resume the normal playback

Press **PLAY**  Button

■ Display on the TV screen

Since no frame number is recorded on the LD (CLV) or the video part of the CDV [unlike the LD (CAV)], the unit divides one second into 30 frames so as to perform Still or Still Advance/Reverse playback on the LD (CLV) or the video part of the CDV. Therefore, a figure between "00" and "29" is displayed beside the "minute and second" indications on the TV screen if Display Button was pressed

- These figures are not displayed during playback of the video part of the CDV.

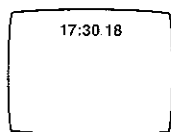

Random Playback

You can play back a disc in a random order



During playback or in the stop mode,

Press **RANDOM**  Button.

- The RANDOM Lamp on the unit lights up
- After all music is played back, the unit stops

■ To resume the Normal Playback

Press **RANDOM** Button again.

Note:

The Random Playback cannot be performed on an LD disc on which no TOC signal is recorded (See page 31)

Various Playback (continued)

Still Playback [LD] [CDV (Video Part)]

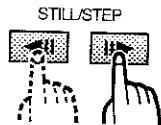

During the normal playback,
Press **Still/Step (Advance or Reverse) 34** Button.

■ **To resume the Normal Playback**
Press **PLAY** Button again

■ **The Disc with the Automatic Picture Stop Function**
If a disc on which a special signal "Picture Stop Code" has been recorded is played back the still playback is automatically performed at the frame designated by the code
If a series of still pictures are recorded on that disc following the point marked with the Picture Stop Code, these still pictures can be advanced or reversed frame by frame with Still/Step Advance or Reverse Button
Press **PLAY** Button to resume the normal playback.

Still Advance/Reverse Playback [LD] [CDV (Video Part)]

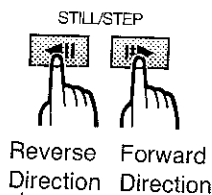

During the still playback,
Press **Still/Step (Advance or Reverse) 34** Button.

- Each time pressing advances or reverses the still picture.
- Button is kept depressed the still picture advances or reverses one frame per second (The indication "1/30" appears.)

■ **To resume the Normal Playback**
Press **PLAY** Button

Multi-Speed Playback [LD] [CDV (Video Part)] To change the Playback Speed

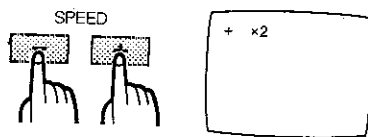

During playback,
Press **SPEED - or + 28** Button.

- Each time it is pressed, the playback speed changes

On Screen Display	Description
x3	3 times normal playback speed
x2	2 times normal playback speed
x1	Normal playback speed
1/2	Playback of 15 frames/sec.
1/4	Playback of about 8 frames/sec.
1/8	Playback of about 4 frames/sec.
1/16	Playback of about 2 frames/sec
1/30	Playback of 1 frame/sec
1/60	Playback of 1 frame every 2 seconds
1/90	Playback of 1 frame every 3 seconds

To change the Playback Direction

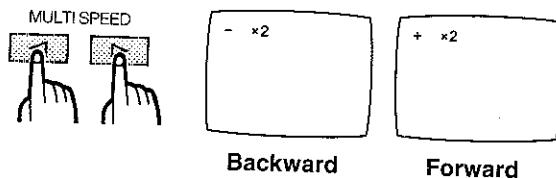

Press **MULTI SPEED 29** ◀ (backward direction) or ▶ (forward direction) Button.

- These buttons enable you to change the direction of the playback whose speed is adjusted with **SPEED -** or **+** Button, i.e. from forward direction to backward direction and vice versa in one of the ten playback modes described above

■ **To resume the Normal Playback**
Press **PLAY** Button

Custom Index Playback

You can memorize a desired segment into the unit

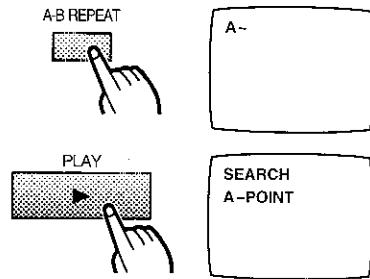

1 During playback,
Press **A-B Repeat** **25** Button.

2 Press **PLAY** **26** Button.
• The playback starts from the point where A-B Repeat Button was pressed

■ **To resume the normal playback**
Press A-B Repeat Button twice

Still & Sound Playback [LD] [CDV (Video Part)]

The playback audio is normally heard during the Still playback.



During playback,
Press **STILL & SOUND** **39** Button.

■ **To resume the Normal Playback**
Press **STILL & SOUND** **39** Button

Art Playback

The picture is processed digitally to obtain a pictorial effect

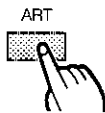

During playback,
Press **ART** **40** Button.

- The playback picture is superimposed with a special pictorial effect
- Each pressing changes the degree of the effect as shown below

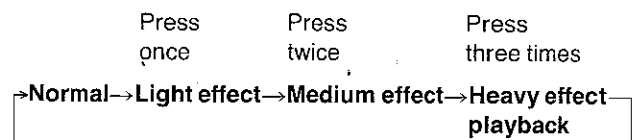

- The Art Playback can also be performed during the following playbacks:
Multi-Speed, Still, Still/Step (Advance or Reverse), Still & Sound Theater Mode and Strobe playbacks.

Notes for Custom Index Playback:

- The Custom Index Playback is released when the operation buttons except PLAY, PAUSE, JOG Dial or SHUTTLE Ring are pressed.
- This playback cannot be performed across the video and audio parts
- This playback cannot be performed during Random Playback and Program Playback.

Note for Still & Sound Playback:

If an LD is used, the Still & Sound playback can be performed only on the side now being played back. If a CDV is used, this playback can be performed only on the video part.

Various Playback (continued)

Strobe Playback [LD] [CDV (Video Part)]

This function enables you to obtain a stroboscopic effect, i.e. to view the still pictures intermittently while the playback audio is heard.

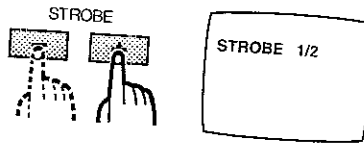

During playback,
Press **STROBE** – or + **32** Button.

On Screen Display	Description
x1	Normal playback
1/2	15 frames/sec.
1/4	About 8 frames/sec.
1/8	About 4 frames/sec.
1/16	About 2 frames/sec.
1/30	1 frame/sec.
1/60	1 frame every 2 seconds
1/90	1 frame every 3 seconds

■ To resume the normal playback
Press **PLAY** **9** Button

Theater Mode (To darken the TV screen or to view the picture in black-and-white) [LD] [CDV (Video Part)]

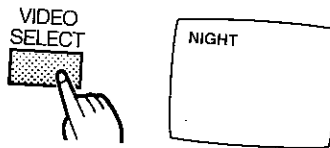

During playback,
Press **VIDEO SELECT** **38** Button.
● Each pressing changes the Theater mode

Press once Press twice

→ **NORMAL** → **NIGHT** → **RETRO**

Digital Field Noise Reduction System [LD] [CDV (Video Part)]

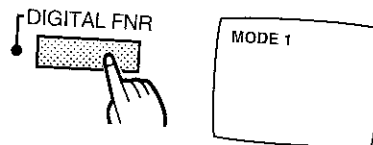

If noise interference or irregular color appears, during playback,

Press **DIGITAL FNR** **17** Button.

● During playback of a movie or live recording disc with the digital field noise reduction system being at its normal position "STANDARD", press the DIGITAL FNR Button to minimize or improve it. You can select the noise reduction system "MODE 1" or "MODE 2"

Press once Press twice

→ **STANDARD** → **MODE1** → **MODE2**

To Turn Off the Multi-Function Display

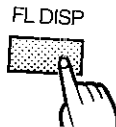

Press **FL DISPLAY** **36** Button.

● The Multi-Function Display is turned off and the DISPLAY OFF Lamp on the unit lights up.

■ To resume the normal state
Press **FL DISPLAY** **36** Button again

Notes for Theater Mode:

- The Theater mode can be selected during the following playbacks in addition to the normal playback: Still, Still/Step (Advance or Reverse), Still & Sound Art and Strobe playbacks.
- When the "NIGHT" mode is selected during the CD playback the screen becomes darker than in the "NORMAL" mode, and when the "RETRO" mode is selected, the blue background changes to black

● Part of the picture in the "RETRO" mode may not be reproduced in black-and-white (i.e. other colors may appear in part of the picture)

Note for Digital FNR:

If DIGITAL FNR Button is pressed during a movie or live recording disc with inferior picture quality, noise interference or irregular color is minimized or improved. The "STANDARD" mode is initially selected after POWER is on. Press the DIGITAL FNR Button to select "MODE 1" or "MODE 2". In these modes, the DIGITAL FNR Lamp is lit

Programmed Playback

To playback chapters or tracks in a user-specified order:

Example: to playback the disc in the order chapter (or track) 3→1→4.

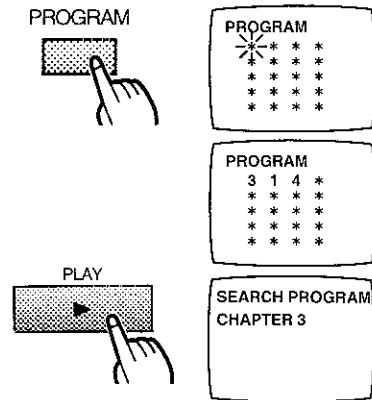

- 1** During playback or in the stop mode, Press **PROGRAM** Button.
 - 2** Press **Numeric** Buttons “3”, “1” and “4”.
 - Up to 20 chapters (tracks) can be programmed in sequence
 - The disc side indication “A” and the chapter number are displayed automatically when an LD is used
 - 3** Press **PLAY** Button.
 - The PROGRAM Lamp lights up and the Program playback starts
 - After all programmed chapters (or tracks) are played back, the unit is put into the stop mode and the programming display appears on the TV screen.
- **To stop the Program Playback**
Press **STOP** Button.
 - **To resume the normal playback**
Press **PROGRAM** Button during the Program playback.

To perform the Program Playback on both sides [LD]

Example: To play back in the order of
Side A Chapter 3
→ Side B Chapter 1
→ Side A Chapter 4

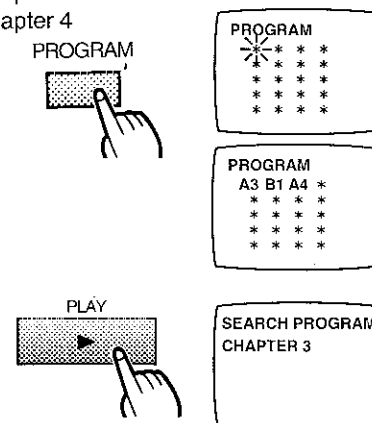

- 1** Press **PROGRAM** Button during playback or in the stop mode.
- 2** Press **SIDE A** (or **SIDE B**) Button and then **Numeric** Button.
SIDE A → “3”
SIDE B → “1”
SIDE A → “4”
- 3** Press **PLAY** Button.

Notes:

- If the number of programmed chapters (or tracks) is beyond 20, the indication “-F” blinks on Multi-Function Display and the indication “FULL” on the TV screen. No further programming is possible
- The chapter or track number on Side A or B being played back is displayed on the Chapter/Track Number Indicators section of the Multi-Function Display
- If you press a wrong Numeric Button, press **CLEAR** Button and then the correct Numeric Button
- When a chapter on Disc A is selected, the corresponding bar above the Chapter Number Indicators on the Multi-Function Display lights up. The bars below the Chapter Number Indicators are for selected chapters on Disc B

Programmed Playback (continued)

To delete the Programmed Chapters/Tracks

(Programmed chapters/tracks can be deleted individually.)

- 1 Press **RECALL** **24** **Button** until the chapter or track number to be deleted blinks.
- 2 Press **CLEAR** **23** **Button**

To add Programmed Chapters or Tracks

(New programmed chapters or tracks are added to the last one.)

Select the desired chapter or track number with Numeric Button

To cancel the Program Playback

(all programmed chapters or tracks)

Press **STOP** **7** **Button** in the stop mode.

Program Skip Function

To skip chapters or tracks during Program Playback

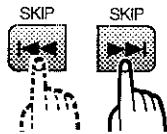

Press **SKIP (Forward or Backward)** **19** **Button**.

- Note that pressing SKIP Backward Button once skips backward to the beginning of the chapter (track) now being played back (not to the previous one).

Note:

Program Skip cannot be performed if the indication "A----B" or "B----A" is displayed on the Multi-Function Display during Program Playback on both sides of an LD

Repeat Playback

Chapter (Track)/Side/All Side Repeat:

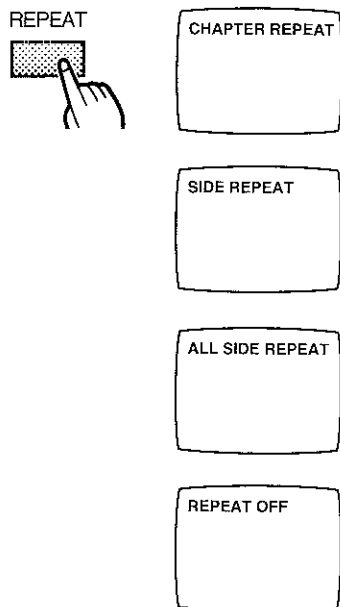

During playback,

Press **Repeat 26 Button**.

- Each time this button is pressed, the display on the TV screen changes in the order shown in the diagram on the left

To play back repeatedly the Chapter (track) now being played back.

To play back repeatedly the Whole Side now being played back.

To play back repeatedly both Disc Sides.

- The function only works when a double-faced LD disc is used

Repeat playback is cancelled

Repeat Playback between Two Designated Points (A-B Repeat)

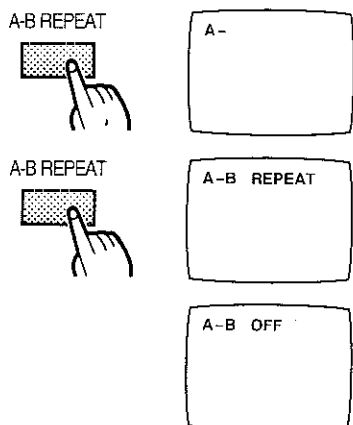

1 During playback, at the point where you wish to start Repeat playback, Press **A-B Repeat 25 Button**.

2 At the desired end point of the Repeat playback, Press **A-B Repeat 25 Button** again.
 • Repeat playback between A and B starts.

■ **To cancel the A-B Repeat Playback**

Press **A-B Repeat Button** to display the message "A-B OFF" on the TV screen

Note: (Chapter Repeat)

When playing back an LD disc without chapter number, pressing the Repeat Button starts Side Repeat playback. The Chapter Repeat playback cannot be performed.

Notes: (A-B Repeat)

- A-B Repeat playback across both sides cannot be performed on an LD disc
- Repeat playback on a CLV disc (long-play LD) is performed according to the time number recorded on the

disc. Therefore, if a CLV disc with time numbers recorded in minutes is used for Repeat playback, the designated start and end points (A and B) may not exactly match the actual Repeat playback start and end points. However, this is not a malfunction.

- On a CDV disc, A-B Repeat playback across both video and audio parts cannot be performed
- A-B Repeat playback cannot be performed during Random playback

Repeat Playback (continued)

Program Repeat Playback



During Program playback,
Press **REPEAT** 26 Button.

- Refer to pages 21 and 22 for information on how to perform Program playback

■ To cancel Program Repeat Playback
Press **PROGRAM** 22 Button.

Random Repeat Playback

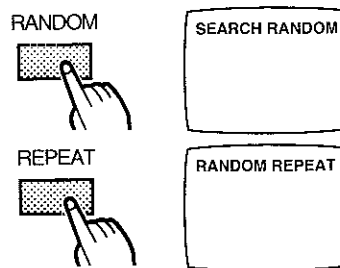

1 Press **Random** 21 Button.

2 Press **Repeat** 26 Button.

■ To cancel Random Repeat Playback
Press **Random** Button

Note:

Random Repeat playback cannot be performed on an LD disc without a TOC signal (See page 31.)

Helpful Hints

Audio Channel Selection

Discs with Stereophonic Sound

Audio Indication	Playback Sound
1/L 2/R	
1/L	
2/R	

Each time you press **Audio Select** **Button** the sound changes as shown sound

- 1/L 2/R Stereophonic sound
- 1/L Left channel audio through both speakers
- 2/R Right channel audio through both speakers

Discs with Bilingual Audio

Audio Indication	Playback Sound
1/L 2/R	
1/L	
2/R	

Each time you press **Audio Select** **Button** the sound changes as shown sound.

- 1/L 2/R Main voice through left channel and sub-voice through the right channel
- 1/L Main voice through both speakers
- 2/R Sub-voice through both speakers

Discs with Digital Audio [LD]



Digital audio discs bear the marks shown at left

You can select digital or analog audio which is output from the Audio Output Connectors on the rear panel by pressing **D/A • CX** **Button** (The indication 'D SOUND' appears on the Multi-Function Display while the digital sound is played back)

The digital sound is always selected after POWER is on.

Notes:

- Since digital audio and analog audio have been recorded at different levels on some discs, the playback volume changes when **D/A • CX** **Button** is pressed to select digital or analog audio
- Depending on the disc used, each push of the **D/A • CX** **Button** will change the indication on a TV screen in the following sequence

→ **DIGITAL** → **CX ON** → **CX OFF** →

CX ON and **CX OFF** indicates that the analog sound system is activated or deactivated

Disc Bearing CX Mark [LD]



Discs bearing mark have an automatic CX noise reduction system for powerful reproduction with minimum noise

If the CX noise reduction system does not function automatically during playback of a disc bearing the mark, press **D/A • CX** **Button** to display the indication **CX ON** on the TV screen

Note:

If a disc without the mark is played back in the **CX ON** mode, the sound quality is inferior

is a trademark of CBS Corporation

This unit conforms with the extended specifications for the CX system

Multi-Function Display

The Multi-Function Display ⑩ indicator lights or blinks corresponding to the operation mode
The illustration below shows all possible indicators

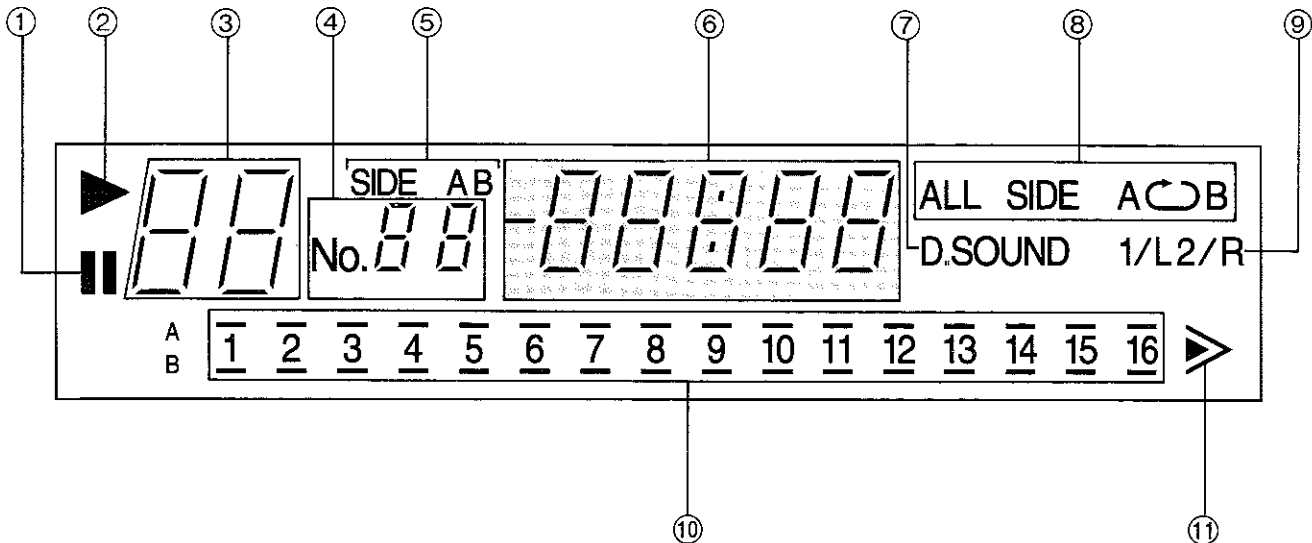

- ① **Pause Indicator**
- ② **Playback Indicator (for all playback)**
- ③ **Chapter/Track Number**
- ④ **Program Number**
- ⑤ **Disc Side Indicator (for LD only)**
- ⑥ **Frame/Time Number and Display of Messages**
 - Refer below for further information on the message display
- ⑦ **Digital Sound Output Indicator**
- ⑧ **Playback Mode Indicator**
- ⑨ **Audio Channel Indicators**
- ⑩ **Chapter/Track Number Indicators**
 - When an LD without a TOC Signal is used one of the bars above and below the numbers is lit
 - However, no indicator is lit if a disc without chapter numbers is used
 - When a CDV a CD or an LD with a TOC signal is used first all bars are lit and the bars go out one by one as the corresponding playback is finished.
 - During the Program playback of a double-faced LD, the bars beyond the Chapter Number indicators indicate the programmed chapters on Disc A. The bars below indicate the programmed chapters on Disc B
 - If an LD with the chapter number 0 is used this number cannot be displayed
- ⑪ **Over Mark**
 - If a disc is used which chapters or tracks above 17 have been recorded, is used, the indication > is lit. If the 17th or the subsequent chapter or track is played back, the '>' is lit

□ The shaded area of the display is for messages
Their meanings are:

- [OPEN] The Disc Tray is open
- [CLOSE] The Disc Tray is being closed
- [OFF] The power is off
- [PLAY] The playback starts (only for LD)
- [A---B] Side A is changed with Side B (only for LD)
- [B---A] Side B is changed with Side A (only for LD)

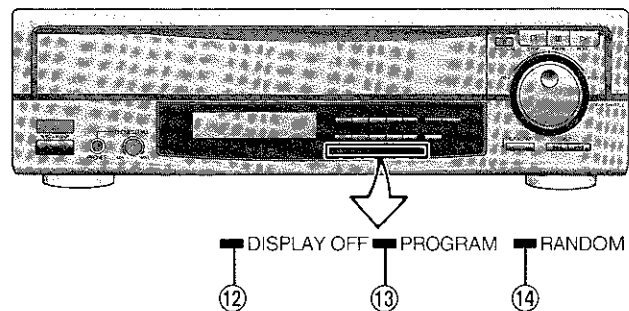
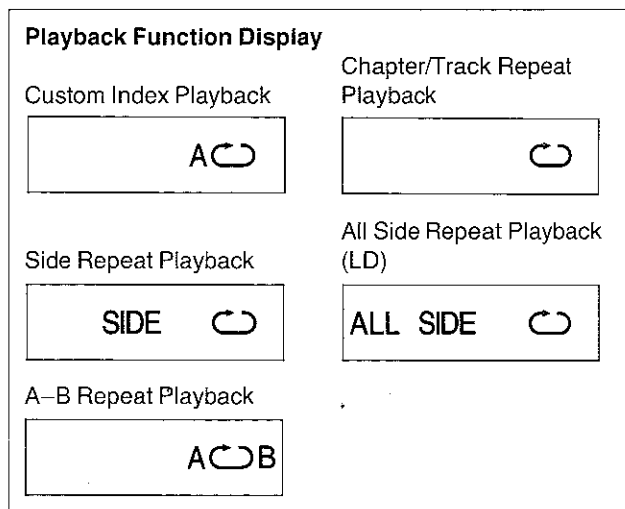

- ⑫ **DISPLAY OFF Lamp**
- ⑬ **PROGRAM Lamp**
 - Lights up during Program Playback or Program Repeat Playback
- ⑭ **RANDOM Lamp**
 - Lights up during Random Playback or Random Repeat Playback

On Screen Display

If the TV is on, the information about a track being played back, elapsed time, or the operation mode of the unit is displayed on the TV screen

Examples of On Screen Display

The following are several display examples. Other displays, e.g. audio function displays, are explained on other pages in this manual

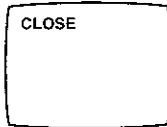
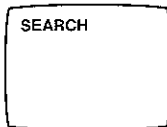
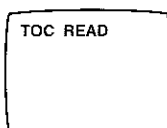
	The Disc Tray is open
	Closing Disc Tray
	Search or Skip function is performed.
	The TOC signals on a disc are being read <ul style="list-style-type: none"> •Displayed when LD with a TOC, CDV or CD disc is loaded

- The TV screen color becomes blue during an LD disc pause or during playback of CDV audio part or CD

Display when the Unit is stopped

A different display appears on the TV screen depending on the type of disc loaded

If CDV or CD disc is loaded, the information about the total number of recorded tracks and their duration are displayed.

- The displayed information may be a bit different from that listed in the explanations supplied with the disc

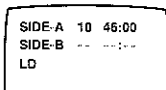
	LD with a TOC Signal (No display appears if a disc without a TOC signal is loaded)
--	--

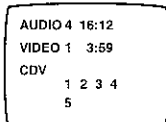
	CDV
--	------------

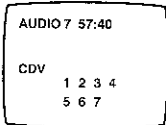
	CD
---	-----------

How to display the On Screen Display during playback

Press **Display (On Screen Indication) [ON] Button**, and one of the following displays appears on the TV screen

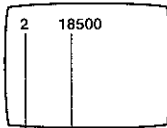
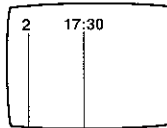
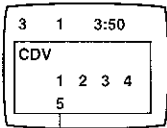
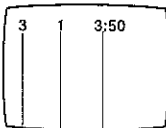
<p>LD [CAV]</p>  <p>Chapter Number Frame Number</p>	<p>LD [CLV]</p>  <p>Chapter Number Time Number</p>	<p>CDV, CD</p>  <p>The song number now being played back flashes on and off (The "CD" is displayed during playback of a CD disc)</p>	➔	<p>One more press</p>  <p>Track Number Index Number Elapsed Time of Track</p>
---	--	--	---	---

- When playing back a CLV disc with no seconds recorded, only the minutes are displayed (e.g. '17: ')
- When playing back a disc on which no chapter numbers have been recorded, no chapter number is displayed.

To Display the Audio Level [CDV] [CD]

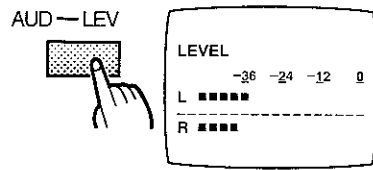

Press **AUDIO LEVEL** **(37)** Button to display the audio level on the TV screen

If it is pressed again, the audio level disappears

- The volume meter is the peak meter type which indicates the maximum registered volume
- The volume level indicates the recorded signal level on a CDV or CD

To Review the Time Display

Each time **TIME MODE** **(35)** Button is pressed, the display changes as shown below

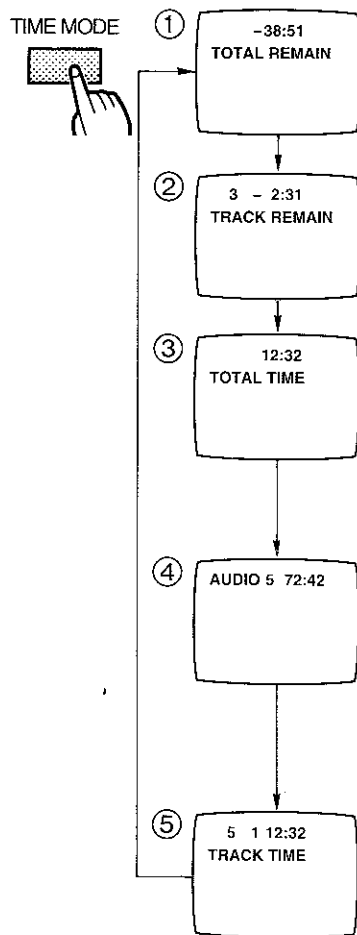

Remaining time of the disc

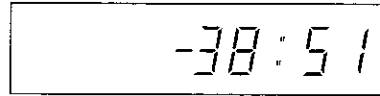

Remaining time of the track now being played back



Total elapsed playback time

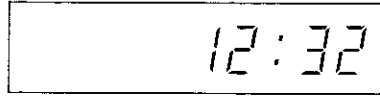

- Elapsed time if playback was started from the beginning of the disc

Recorded content

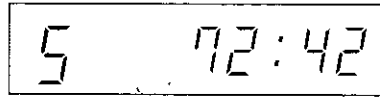

- Number of tracks and total recording time
- If a CDV is used, the contents of the video and audio parts are displayed separately

Elapsed time of the track now being played back

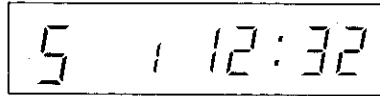

- When an LD is used, a chapter number now being played back and the total elapsed time of the playback from the beginning of the disc are displayed
- If **DISPLAY** **(33)** Button is pressed, the time display disappears

Notes for Audio Level:

- The numerical volume level may differ from the recording level of a cassette deck.
- The volume level is not displayed during the playback of a CDV's video part
- The low-frequency signal cannot be displayed correctly.

Notes for Time Display:

- During playback of an LD with TOC the time display is displayed alternately in the order of ④↔⑤

- Each time TIME MODE Button is pressed during the Random playback, the time display is changed in the order to ②→④→⑤→② (CDV CD)
- The time information displayed on Multi-Function Display may differ a bit from that listed in the explanations supplied with the disc. This is because the explanations list only the actual playing time of each track, while this unit displays the playing time including the time of the intervals between tracks

Cautions

To ensure safe operation, please observe the following:

Formation of Condensation inside the Unit

Condensation (dew) forms when warm air comes in contact with a cold object, for example on a window in a heated room in winter

Condensation may form in the unit if:

- The unit is in a room where the heater has just been turned on.
- The unit is in a room with steam or high humidity
- The unit is brought from cold surroundings into a well-heated room, especially in winter
- The unit is suddenly brought from cool surroundings, such as an air-conditioned room or car, to a place which is hot and humid

When condensation has formed inside the unit, the unit may not operate correctly

Normally, as condensation forms gradually, it may take about 10–15 minutes before the unit functions incorrectly due to condensation

Wait about 20 minutes before trying to use the unit if the unit was in one of the conditions described above and confirm that no condensation has formed in the unit

Cautions for Use

Follow these cautions to avoid malfunction or serious damage to the unit

- **Disconnect the Power Cord from the AC outlet by pulling the plug, not the cord.**
- **Keep the Power Cord away from heating appliances.**
- **Do not put any heavy object on the Power Cord.**
- **Do not attempt to repair or reconstruct the Power Cord.**
- **Keep the unit away from sources of liquids, such as basins, bathtubs, and so on.**
- **Do not remove the outer panel.**
 - Touching internal parts of the unit is dangerous, and may cause serious damage to the unit
- **Do not use the unit if there is lightning.**
 - Unplug the Power Cord from the AC outlet as soon as possible

Exterior influences such as lightning and static electricity can affect normal operation of this unit. If this occurs, turn the unit off and on again with POWER Button, or disconnect and then reconnect the Power Cord to the AC outlet. The unit will operate normally

Notes for Installation

- **Place the unit on a even and stable place that is well ventilated.**
 - The rear panel becomes hot during operation, but this is not a malfunction
- **If the unit is placed near the TV:**

The picture and audio may be adversely affected during playback of the unit. If this occurs, place the unit farther away from the TV.
- **Do not place the unit in the following places:**
 - In a room exposed to direct sunlight for long periods of time
 - Near a strong light source or a heater
 - Where there is steam or soot
 - Where there is dust or humidity or a strongly magnetized object

Maintenance

- **Wipe the body and operation panel of the unit with a soft, clean cloth.**
 - If you use a chemically treated cloth for cleaning, refer to its notes on use
 - For persistent stains, use a soft cloth moistened with mild detergent and water, and then wipe with a dry cloth

Handling Cautions

- **Do not place anything heavy on the unit.**
 - Do not attempt to place a TV on the unit
- **When the unit is moved:**
 - Be careful not to drop the unit or subject it to other strong shocks
 - Make sure that the unit is disconnected from all connection cords
 - For a distant transport, wrap it in a blanket or rug to prevent its being scratched
- **Keep the unit away from insecticides or volatile substances. Do not keep the unit touching rubber or vinyl material for long periods of time.**
 - These materials may cause discoloration and surface damage to the unit

Noise Interference on the TV Screen while Receiving a TV Broadcast

Depending on the reception condition of the TV broadcast, noise interference may appear on the TV screen while you watch a TV broadcast and the unit is left on. This is not a malfunction of the unit or the TV. If this occurs, turn off the unit

Notes for Disc

This unit can play back discs bearing the trademarks shown below



TOC (Table of Contents) Signal

The TOC signals are recorded onto the beginning of all CD and CDV discs. This signal is similar to a table of contents and includes information about the music and their playing times. Some LD discs also contain this signal.

The Random playback of this unit do not work on discs without a TOC signal.

Notes for Use

- CED and VHD system video discs cannot be played back with this unit
- Since this unit complies with the NTSC color TV system, discs with other color TV systems (PAL or SECAM) cannot be played back
- This unit does not correspond to CD Graphics and CD-ROM specifications
- Do not use a CD stabilizer

Never use Cracked or Warped Discs.

- Since the disc rotates at a high speed, use of cracked or disformed (warped) one is quite dangerous. Never attempt to repair a broken disc with adhesive tape or glue and then use it.

This will damage the unit.

- Should a strange noise or vibration be heard or occur after starting playback, i.e. the disc does not rotate smoothly, immediately press the STOP or the OPEN/CLOSE Button to stop the disc rotation.



Cracked



Chipped

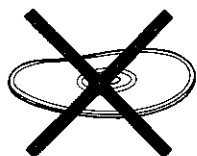

Disformed (warped)

- Place one disc in the Disc Tray according to the proper recession guide for playback. Never place two or more discs in the Disc Tray and never attempt playback with a disc that has slipped out of the recession.

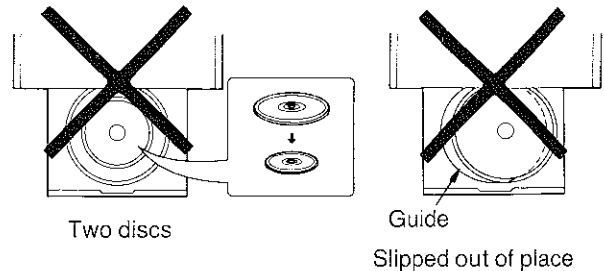

Notes for Storage

- After use, always put the disc into its case and store it in a vertical position. Storing discs in a slanted position or stacked may cause them to become warped.
- Do not store the discs in places exposed to direct sunlight, high temperature or high humidity.
- Never attempt to stick a label on a disc. Be careful not to scratch the disc surface.

Maintenance

- To clean a disc soiled with fingerprints or dust, use a soft and dry cloth.
- If the surface is extremely dirty, dip a soft cloth into water and wring the cloth well before wiping the disc. Then wipe again with a soft and dry cloth.
- When wiping discs, always move the cloth from the center hole toward the outer edge.

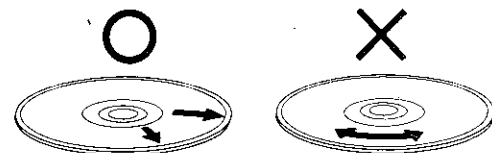

(Circular scratches along a line of pits made by circular wiping are more likely to cause noise.)

- Do not use benzene, thinner, nor a record cleaner.
- Do not use an antistatic agent. This may damage the disc.

Your attention is drawn to the fact that recording, broadcasting, showing, playing to the public and rental of prerecorded discs may infringe copyright laws.

Before Requesting Service

Symptom	Check Points
No power	<ul style="list-style-type: none"> •The Power Cord is not connected to an AC outlet
The Disc Tray cannot be opened.	<ul style="list-style-type: none"> •The unit is not turned on
Playback does not start. Playback stops immediately after PLAY Button is pressed.	<ul style="list-style-type: none"> •The disc is not loaded correctly •Unrecorded side of the disc is selected •Condensation has formed in the unit •The disc is dirty (Wipe it with a soft, clean cloth)
No picture is played back. Picture is obscure or unstable.	<ul style="list-style-type: none"> •The TV (monitor) is not on •The connection is not correct •The speakers have been placed close to the TV •The disc is dirty or scratched •Condensation has formed in the unit.
Still, Still Advance (Reverse) or Multi-Speed playback cannot be performed.	<ul style="list-style-type: none"> •The disc being played back is the CLV or the video part of CDV which cannot be played back in Still, Still Advance (Reverse) or Multi-Speed playback.
Picture is distorted/unstable during Scan Forward/Backward playback.	<ul style="list-style-type: none"> •This is not a malfunction.
No sound is reproduced. The sound can hardly be heard.	<ul style="list-style-type: none"> •The audio input selection is not correct on the TV (monitor) or the stereo system (amplifier or AV selector). •The connection is not correct. •The volume adjustment is not correct on the TV (monitor) and the stereo system •If an amplifier is set to the "optical digital input" position during analog audio playback, the audio cannot be heard •The CX system is set to "ON" when a disc without CX mark is used •The pause or still playback is performed. •The Multi-Speed playback is performed •The disc is dirty or scratched. •Condensation has formed in the unit.
Remote Controller does not work.	<ul style="list-style-type: none"> •Batteries have not been loaded correctly •Batteries are exhausted. •The Remote Controller is not pointed at the Remote Sensor of the unit •Distance is too far (beyond 7 m from the unit). •There is an obstacle between the Remote Controller and the Remote Sensor
Searching time is too long.	<ul style="list-style-type: none"> •The disc is dirty or scratched.

Specifications

Information for Your Safety











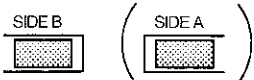















Power Source:	AC 120 V 50–60 Hz
Power Consumption:	41 W (Power off: approx 7 W)

Television System:	NTSC
Format:	Laser Vision Video Disc System, Compact Disc with Video and Compact Disc Digital Audio System
Weight:	20 46 lbs. (9.3 kg)
Dimensions:	16 ⁵ / ₁₆ " (W) × 5" (H) × 16 ⁵ / ₁₆ " (D) [430 (W) × 127 (H) × 414 (D) mm] (protruding parts are not included)
Operating Temperature:	+5°C ~ +35°C (+41° ~ +95°F)
Operating Humidity:	5 ~ 90% (provided that no condensation forms)
Disc Format:	<ul style="list-style-type: none"> (1) Laser Vision Disc <ul style="list-style-type: none"> 12" (30 cm) Long Play Disc (CLV) 1800–600 rpm 2-hour playback time (max) on double sides 12" (30 cm) Standard Play Disc (CAV) 1800 rpm 1-hour playback time (max) on double sides 8" (20 cm) Long Play Disc (CLV) 40-minute playback time (max) on double sides 20-minute playback time (max) on single side 8" (20 cm) Standard Play Disc (CAV) 28-minute playback time (max) on double sides 14-minute playback time (max) on single side (2) Compact Disc <ul style="list-style-type: none"> 5" (12 cm) Disc 500–200 rpm 74-minute playback time (max) on single side 3" (8 cm) Disc 500–300 rpm 20 minute playback time (max) on single side (3) Compact Disc with Video <ul style="list-style-type: none"> Video Part 2700–1800 rpm 5-minute playback time (max) on single side Audio Part 500–300 rpm 20-minute playback time (max) on single side
Video Signal Output Level:	1 V p-p (at 75 ohm, synchronizing load)
S-Video Output Level:	Y Output/1 Vp-p (at 75 ohm, synchronizing load)
(Y/C Separate Signal Output)	C Output/0.286 Vp-p (at 75 ohm)
Audio Signal Output Level:	<ul style="list-style-type: none"> (1) Digital audio output; 200 m Vrms (1 kHz, –20 dB) (2) Analog audio output; 200 m Vrms (1 kHz, 40% modulated)
Digital Audio Signal Output Characteristic:	<ul style="list-style-type: none"> (1) Frequency response; 4 Hz–20 kHz (EIAJ) (2) S/N ratio; 115 dB (EIAJ) (3) Dynamic range; 98 dB (EIAJ) (4) Wow and flutter; Below measurable limit (5) Total harmonic distortion; 0.0023% (EIAJ) 1 kHz
Headphone Connector:	32 ohm (30 mW), Impedance; more than 8 ohm

Quick Reference

Operate by following the direction of the arrows

- Turn the unit on
- Load the disc

Operation	Procedure
Playback	
Changing Side A with Side B (or vice versa)	
To skip to the desired scene (song)	Backward  Forward 
To access the desired scene (song)	 ~  
To start playback from the desired frame number or time number	 →  ~  → 
Still or Still Advance/Reverse playback	Backward  Forward  • Press either button to perform Still Playback
Changing playback speed	 
Changing playback direction	 
Still picture while the playback audio is heard	
To view the digitally processed picture	
To view the still pictures intermittently while the playback audio is heard	 
To darken the TV screen or to view the picture in black-and-white	
Program playback	 →  ~   → 
Repeat playback of Chapter, Track, Single Side, or All Sides	

PANASONIC COMPANY, DIVISION OF MATSUSHITA ELECTRIC CORPORATION OF AMERICA
One Panasonic Way Secaucus, New Jersey 07094

PANASONIC COMPANY (WEST) OF AMERICA, DIVISION OF MATSUSHITA ELECTRIC CORPORATION OF AMERICA
6550 Katella Avenue Cypress, CA 90630

PANASONIC SALES COMPANY, DIVISION OF MATSUSHITA ELECTRIC OF PUERTO RICO, INC. ("PSC")
San Gabriel Industrial Park 65th Infantry Avenue KM 9 5 Carolina Puerto Rico 00630

MATSUSHITA ELECTRIC OF CANADA LIMITED
5770 Ambler Drive, Mississauga Ontario L4W 2T3

